



*digsy*<sup>®</sup> compact

## Control System for Mobile Applications

Electronic automation and data system  
with integrated hydraulic control  
**CAN-BUS** with **CAN**<sub>open</sub>-protocol

## Automation Power for Mobile Outdoor Machinery

**digsy® compact**, an electronic automation system for centralized and decentralized control networks, has been especially developed for the requirements of mobile outdoor machinery in rough environmental conditions and is suitable for on-board supply voltage. Apart from performing logic, control and arithmetic functions the system is also capable of controlling the entire hydraulic system.

**digsy® compact** features a high degree of functionality and a large number of inputs and outputs for a direct connection of sensors enabling the detection of physical values such as pressure, temperature, speed, level, lengths or for the driving of actuators such as solenoids, hydraulic proportional valves or pumps. The automation system **digsy® compact** enables you to build up a

### “TOTAL CONTROL SYSTEM”

with just one component. This is cost saving and makes the system easy to handle from the logistical point of view, too. It may be used both as an individual control and within complex control networks with **CANopen**-protocol.

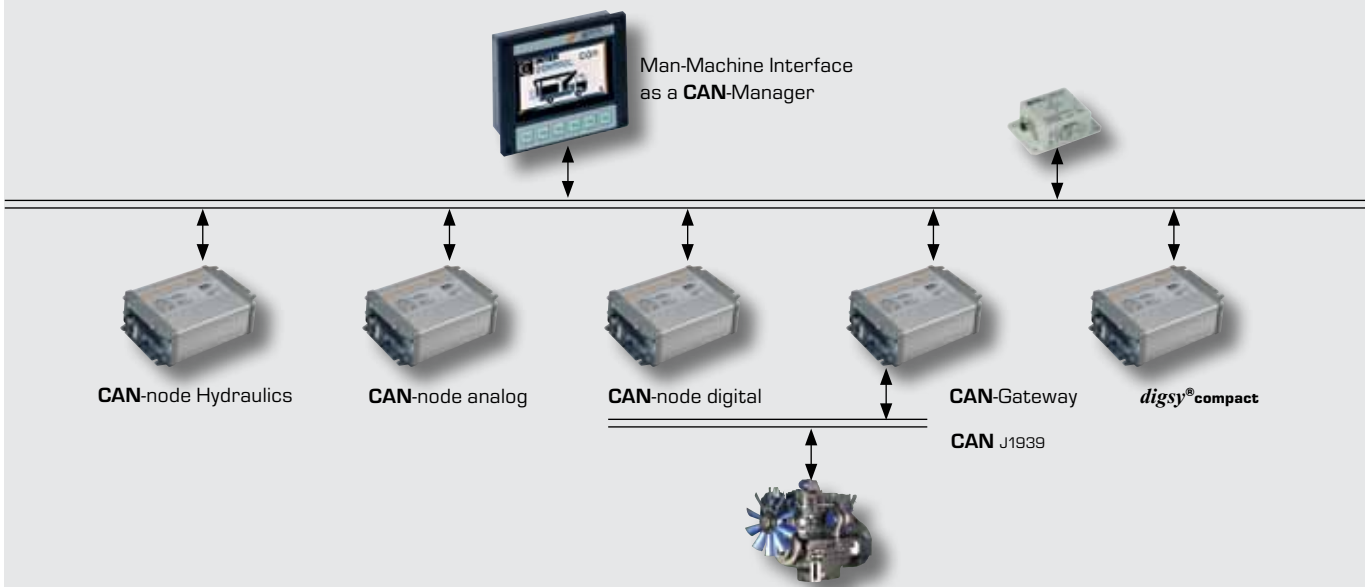

## Flexible and Customer-Friendly Modular System



**digsy® compact** features the flexibility of a modular system and is thus superior to simple compact control units. The fully expanded version of the flexible modular system is equipped with two modules whose total number of 110 connection pins give proof of its high level of functionality.

The fully expanded **digsy® compact I** includes a CPU-module and an I/O-module. Both modules are equipped with a 16-bit microcontroller and a CAN-controller. The modules are connected via an internal serial interface.

The CPU-module itself is an autonomous unit and obtainable as **digsy® compact II** with an identical housing but without I/O-module. **digsy® compact III** accommodates two CPU-modules.

In addition, the **digsy® compact** family comprises further components – the so-called “Subunits”. These are passive **CAN**-nodes with I/O-functionality that are accommodated in the same housing. Combinations between the control unit **digsy® compact II** and a **CAN**-node (subunit) are possible as well. Thus, the system requires only a minimum of space for installation and allows a maximum adaptation to the application while, at the same time, it is cost-saving from the logistical point of view. In all cases it is possible to use the identical, pressurized-water-tight and mechanically stable housing suitable for outdoor installation.

## Intelligent Hydraulic System CAN-Node

Even the smallest expansion stage of the automation system, the *digsy<sup>®</sup>compact II*, is equipped with 8 current controlled PWM outputs. Consequently, this expansion stage is suitable for direct mounting onto hydraulic valve blocks without any additional protective housing.

Thus, *digsy<sup>®</sup>compact II* is a decentralized **CAN**-hydraulic-node with preprocessing, e.g. with 4 analog check-back inputs. The possibility of parameterization (ramps, minimum/maximum current and characteristic) enables the use of valves from different producers.

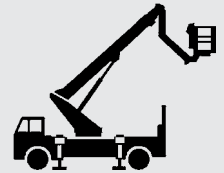

## CAN-Gateway – Access to Engine Data

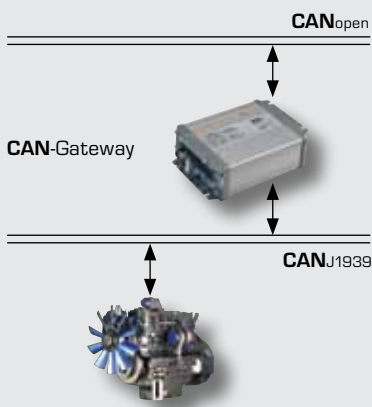

*digsy<sup>®</sup>compact* supports the **CANopen**-protocol and may be operated both as a **CANopen**-Slave and as a **CANopen**-MANAGER. Producers of Diesel engines generally use the **CAN**-protocol SAE J1939. The *digsy<sup>®</sup>compact I* with its 2 separated **CAN**-controllers may also be used as a gateway between **CANopen** and J1939 networks. This creates a BUS-architecture with two independent BUS-networks and has the advantage that the J1939-BUS is only partially accessed from the control unit side and consequently the "Engine-CAN-network" is not affected.

Direct access to the engine data enables the user to visualize the engine states (*digsy<sup>®</sup>CMV* or *digsy<sup>®</sup>CGM*) or to memorize them for diagnostic and service purposes. At the same time, the control unit can exert an influence on the engine in order to vary, e.g. in dependence on the superstructure accessory drive, the engine speed (load limit sensing control).

## Serviceability – Your Customer Benefit

The application program (AWP) is stored in a non-volatile memory (flash EPROM). It is protected against unauthorized access and changes. Parameterizations in the form of characteristic curves, setpoint values, type-specific individual parameterizations, calibration data for sensors and actuators as well as control configurations may be stored in a non-volatile memory, too.



These data are displayed in the vehicle via a visualization system and they are changeable. With the visualization systems *digsy<sup>®</sup>CMV* or *digsy<sup>®</sup>CGM*, which are linked to the *digsy<sup>®</sup>compact* via the **CAN**-BUS, it is possible to make fault diagnoses or, if accordingly programmed, they can be used as an "on-board service tool".

The shape of the housing makes the "Black Box"-system *digsy<sup>®</sup>compact* very easy to handle and worldwide on-site maintenance requires no special knowledge. Due to the central connector suitable for mobile use the unit can be just as easily exchanged as any other mechanical component in the vehicle.

## Control of Proportional Hydraulic Valves

Apart from its function as a logic control and closed-loop process control the **digsy<sup>®</sup>compact** is also able to drive and to current-control proportional hydraulic valves of different producers. In this context, the decisive advantage is that – in contrast to valves with integrated electronics – the process adaptation within the control system can be effected taking the current process situation into account. Besides, it is possible to use more favorably priced standard valves which, can be easier procured, if they have to be replaced.

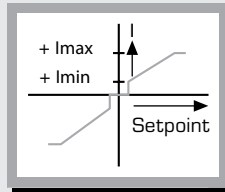

### Programmable current limits

- Imin and Imax freely programmable and parameterizable
- adaptation of valves of different producers within a system

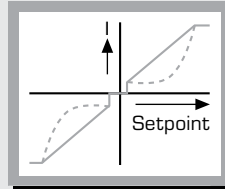

### Programmable characteristic curves

- linear or progressive/degressive
- individually for both directions
- process-conditioned parameterizable

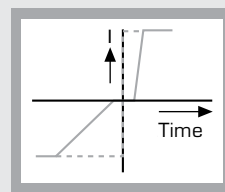

### Programmable time response

- with and without ramps
- individually for both directions
- process-conditioned parameterizable
- for adapting the acceleration and deceleration in the case of different load ratios
- precision adjustments, especially when moving heavy loads

### Closed-loop current control

- the PWM outputs to the hydraulic proportional valve are current-controlled

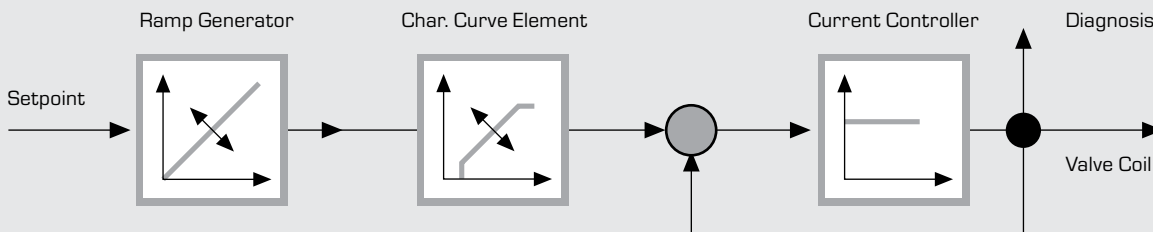

## User-Programmability Increases Flexibility

To program the **digsy<sup>®</sup>compact**, the programming software PROSYD1131 is available.

This software is a very convenient and user-friendly program development environment according to IEC1131-3 standard.

It enables the programming, screen display, and documentation in various types of representation or programming methods.

- IL instruction list
- LAD ladder diagram
- FC function chart
- ST structured text
- SL sequencer language

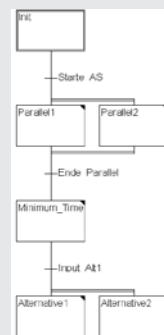

Sequencer Language

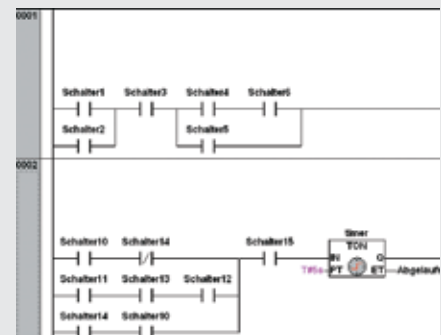

Ladder Diagram

```

0001  ; Den Sinus einer Zahl
0002  LD  r1
0003  SIN
0004  MUL 1000
0005  ST  sinus
0006
0007  ; Den Cosinus einer Z
0008  LD  r1
0009  COS
0010  MUL 1000
0011  ST  cosinus
0012
0013  ; Die Zahl wenderschal
0014  LD  r1
0015  ADD 0.1
0016  ST  r1
    
```

Instruction List

```

0001 run_String := "Start";
0002 IF NOT run THEN;
0003   RETURN;
0004 END_IF
0005 run_String := "Stop";
0006
0007 IF updirection THEN
0008   IF yVal := -100 THEN
0009     updirection := FALSE;
0010   IF xVal := 0 THEN
0011     rightdirection := TRUE;
0012   ELSE
0013     leftdirection := TRUE;
0014   END_IF
0015 ELSE
0016   yVal := yVal -2;
    
```

Structured Text



Function Chart

## Advantage

Due to the following functions the software provides considerable advantages during commissioning and trouble shooting:

- offline program testing (simulation without target system)
- online representation with true/false states (diagnosis directly on the target system)
- step-by-step program processing
- trace run
- breakpoints
- graphical status representation

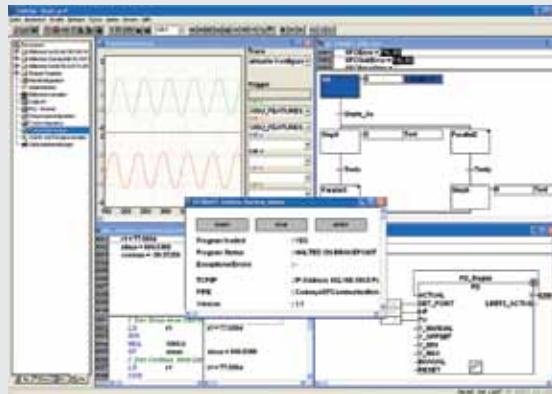

## More Than a Logic Control

Apart from pure control functions the **digsy<sup>®</sup>compact** with its powerful micro-processors also performs complex arithmetic functions for which so far separate electronic devices were needed.

This includes, inter alia, the following:

- joystick control
- anti-spin control
- leveling
- control of the entire hydraulic system
- load moment limitation
- synchro control
- data memorizing
- operating range limiting
- hydrostatic drive control
- load limit sensing control

## A Wide Variety of Applications

**digsy<sup>®</sup>compact** is used wherever it comes to equipping mobile outdoor machinery with an automation system of outstanding reliability:

- excavators/dredgers
- fire trucks
- mobile cranes
- construction machinery
- aircraft towing vehicles
- garbage trucks
- container spreaders
- wharf cranes
- platform vehicles
- earth drilling machines
- lifting platforms
- snowplows
- harvesting machines
- vehicles for cleaning sewers
- rail cranes
- airport staircase trucks
- sweeping machines
- road finishers
- driverless container vehicles
- street cleaning vehicles
- tower cranes
- road milling machines
- forest machinery
- mining machinery
- forklift

## Safety Functions

**digsy<sup>®</sup>compact** features a series of functions that make the system safer.

These include among other things:

- 2 processors
- processor-independent watchdog
- additional shutdown output (as an option)
- in the case of a reset (watchdog) all outputs (digital, analog, PWM) become de-energized in a defined way
- supply voltage monitoring for undervoltage and overvoltage
- outputs backreadable
- inputs with testing
- temperature monitoring
- checksum for flash EPROM
- dynamic memory test for RAM, flash EPROM
- fault management both in the system and the networked system

## CANopen

The automation system **digsy<sup>®</sup>compact** is equipped with a **CAN-BUS** interface 2.0A (2.0B compatible). In mobile machinery the **CAN-BUS** is the most common 2-wire data BUS that is used as a standard in virtually all European cars.

**CANopen** is used as a unified **CAN-BUS** protocol for superstructures of mobile machinery. **CANopen** fulfills a series of functions which in the case of a decentralized control system are necessary for a safe data interchange.

The message-orientated method of operation of the **CAN-BUS** makes a configuration of the **CAN-network** necessary. For this, INTER CONTROL offers the appropriate tools.

## Block Diagram

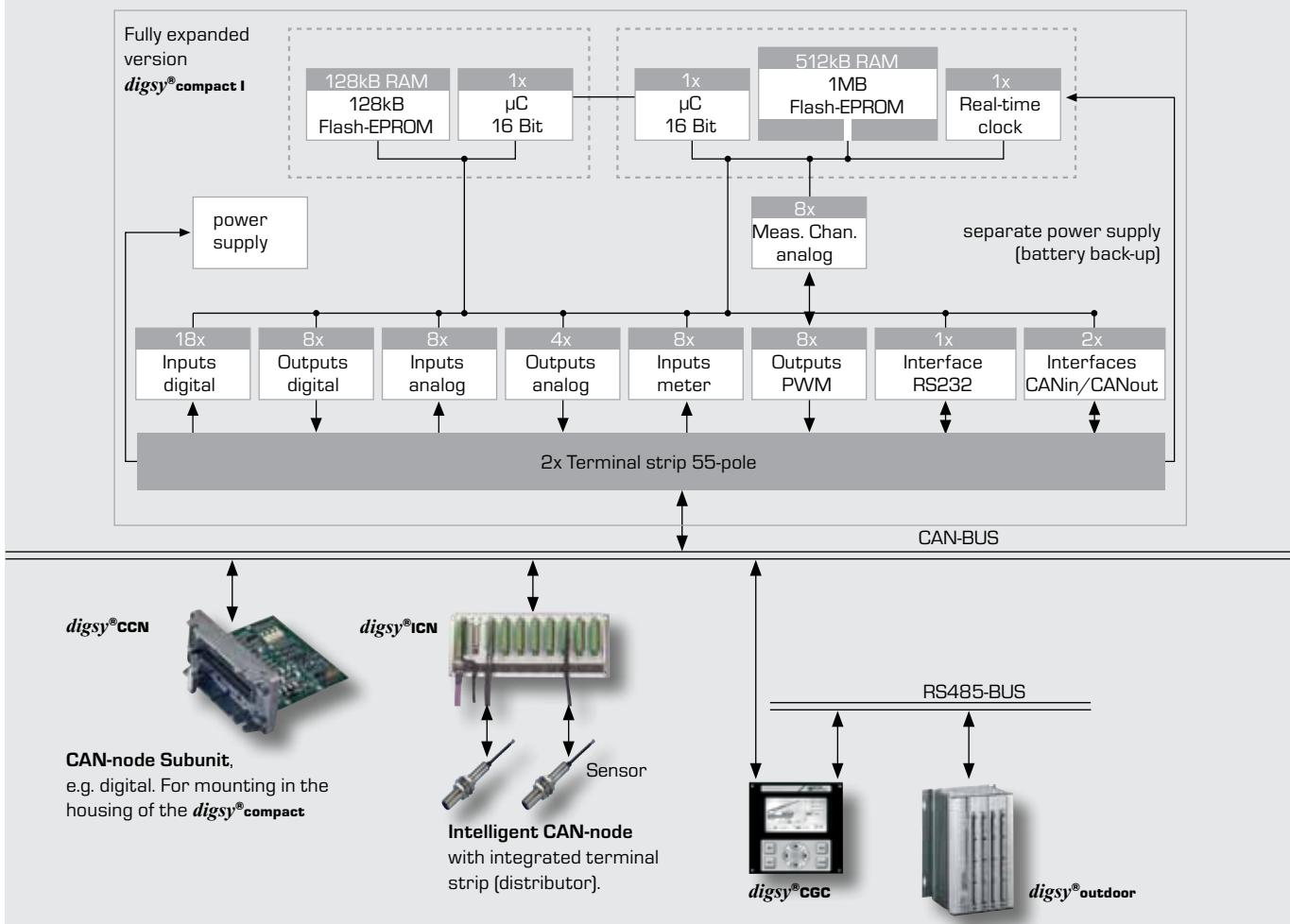

## Technical Data

Type No.	4885.27107	4885.27105	4885.27207	4885.27205	4885.27307	4885.27305
Function	compact A I	compact F I	compact A II	compact F II	compact A III	compact F III
1st Microcontroller	80C167, 20 MHz	80C167CS, 40 MHz	80C167, 20 MHz	80C167CS, 40 MHz	80C167, 20 MHz	80C167CS, 40 MHz
2nd Microcontroller	80C164, 20 MHz	80C164, 20 MHz	-	-	80C167, 20 MHz	80C167CS, 40 MHz
RAM	128KB+512KB	128KB+1MB	512KB	1MB	512KB+512KB	2x 1MB
FLASH-EPROM	128KB+1MB	128KB+1MB	1MB	1MB	2x 1MB	2x 1MB
non-volatile FRAM	-	8192 words	-	8192 words	-	2x 8192 words
Real-time clock	1	1	1	1	2	2
CAN-bus-interfaces	2	3	1	2	2	4
RS-232-interfaces	1	2	1	2	2	4
Connector 55-pole	2	2	1	1	2	2
<b>Inputs</b>						
digital 12/24V (1) (2)	18	18	10	10	20	20
analog 0...10V / 0...20mA, 12 Bit	4	-	4	-	8	-
analog 0...10V / 0...20mA, 10 Bit	4	4	-	-	-	-
analog 0...10V, 12 Bit	-	4	-	4	-	8
analog 0...20mA, 12 Bit	-	4	-	4	-	8
single-channel/dual-channel counters, 20 kHz (3)	8E/3Z	8E/3Z	2E	2E	4E	4E
<b>Outputs</b>						
digital 1,8A (3A max.) (4)	8	8	-	-	-	-
analog 0...20mA, 9 Bit (5)	4	4	-	-	-	-
analog 0...20mA, 12 Bit (5)	-	1	-	1	-	2
PWM with current control 10 Bit, 1,8A (3A max.) (6)	8	8	8	8	16	16

(1) plus or ground switching, configurable in groups of 4 • (2) also for using in periodical longtime measures • (3) also configurable as digital inputs • (4) short circuit proof, overload-proof, backreadable; outputs can be connected in parallel; also configurable as digital inputs • (5) usable as a reference source for joysticks • (6) also configurable as digital outputs

## Technical Data

### Counting inputs

- number: 8 multi-function inputs. The signal input channels of the counters are configurable. 8 signal input channels function either as 8 counters which are independent of each other or as 3 incremental encoder inputs. In this case, the signal inputs are configurable in pairs (max. 2x3 A/B signals for direction detection, by 90° out of phase). The functionality of the counters can be configured as well.
- $f_{\text{max}}$  = 25kHz (AB-counters: 10kHz)
- unit of measurement: Absolute value in pulses and velocity value in pulses/time reference. (The time reference is programmable, e.g. in min.). In the case of incremental encoder inputs the direction is programmable too.
- range: 16 bit velocity value 32 bit absolute value, measuring window parameterizable from 10 ms to 2.55s

### Power supply

- 12 V/24 V nominal voltage
- 8 V-32 V DC on-board voltage
- supply failure detection
- load-dump-protection
- separate battery connection for back-up supply of the clock

### Housing

- The housing is designed so that it can be mounted on the outside of the vehicle without requiring any additional protection.
- compact design
  - IP 66K (pressurized-water-tight)
  - impact resistant
  - saltwater resistant
  - Goretex® filter
  - EMC proof
  - aluminum section w. die-cast aluminum cover
  - quick mounting via fastening flanges

### Connection system

- plug connectors IP-67
- two-part connection
- quick-release lock
- mobile applications standard

### Interfaces

- 2 CAN-BUS interfaces Physical bus: according to ISO 11898 Full-CAN, CAN-specification 2.0A and 2.0B Protocol: CANopen Baud rate: 500 kbit/s Connection for incoming and outgoing line Integrated BUS termination
- 2 serial interfaces TXD, RXD, CTS, RTS or 2 x TXD, RXD Baud rate: PC-compliant, freely adjustable

### Firmware

- **digsy®compact** features an IEC 1131 runtime system and a **CANopen** runtime system. The following functions are supported:
  - times
  - counters
  - flags
  - word flags
  - arithmetic functions
  - trigonometric functions
  - comparative functions
  - string functions
  - system blocks
  - function blocks
  - data blocks
  - data memorizing
- Data, e.g. measured values, can be transferred to the integrated non-volatile memory. This data memory may be used, inter alia, as a memory for operating data.
- further applications:
  - acquisition and evaluation of measured values and job-account data (hired machinery)
  - input of preset values from externally calculated projects (road construction machines)
  - operating data analysis
  - historical data memory

® Goretex (registered trademark of Gore)

## Environmental Conditions

**digsy®compact** was designed and developed according to the latest standards for mobile outdoor applications. **digsy®compact** meets the high demands made on machinery designed for mobile use.

It is:

- suitable for mobile use
- immune to vibration
- shock proof



Tests according to:

- Machinery directives (CE symbol)
- EMC directives acc. to automotive standards
- Immunity to interference in vehicles acc. to:
  - DIN 40839T1
  - DIN 40839T3
  - EG-RL-95-54/EG
- Mechanical stress acc. to:
  - DIN IEC68 T2-6
  - DIN IEC68 T2-27
  - DIN IEC68 T2-29

- Climatic stress acc. to:

- IEC 68T2-1
- IEC 68T2-2
- IEC 68T2-14
- IEC 68T2-30
- Degree of protection: IP66K IP-class acc. to DIN 40050
- Operating ambient temperature: -40 °C to +80 °C (-40 °F to +176 °F) (load-dependent)

## Accessories

for **digsy®compact** and **digsy®subunits**

### Cable

Type No. 4306.10.004

Complete with socket connector and cover. Single-wire sealing, numbered single-wires 3 m long.

for **digsy®compact** and **digsy®subunits**

### Connector set

Type No. 4305.35.003

Consisting of socket housing, crimp contacts, single-wire sealing and connector cover.

for **digsy®compact** and **digsy®CGM**  
**Software "PROSYD1131"**

Type No. 4395.20.100

Programming and test software acc. to IEC 1131-3 License for 1 workstation

**Inter Control**

Hermann Köhler Elektrik GmbH & Co. KG  
Schaffhofstraße 30  
D-90411 Nürnberg, Germany  
Fon +49(0)911 9522-5  
Fax +49(0)911 9522-857  
Email: [info@intercontrol.de](mailto:info@intercontrol.de)  
Internet: [www.intercontrol.de](http://www.intercontrol.de)

Subject to change without notice.

The characteristic specified in this document are not warranted characteristics.

This brochure may also be downloaded (PDF-file) from the internet at the address: [www.outdoor-controls.de](http://www.outdoor-controls.de)